

Varenummer: 03445100
Beskrivelse: Fluro Heavy Duty Ledleje GE 100 EW-2RS
Hul Ø100
Note: 100

Mål

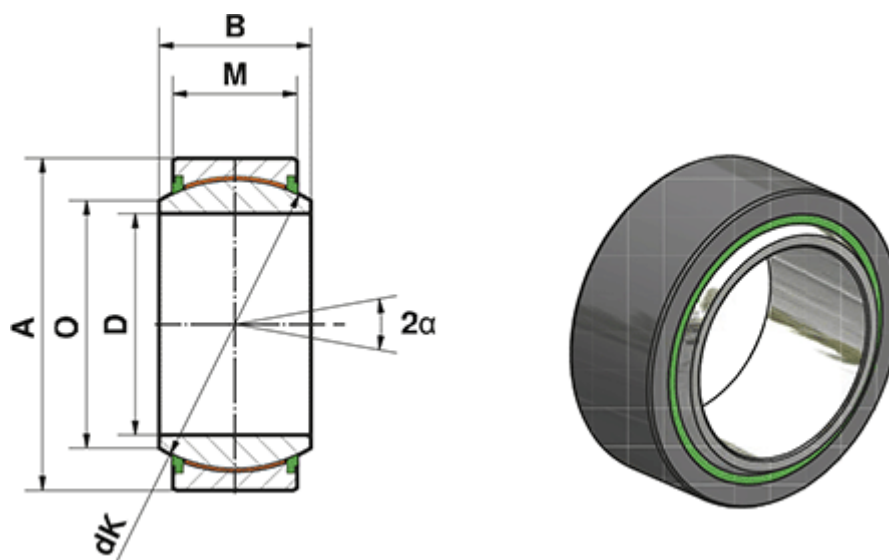

A	= 150
a (grader)	= 7
B	= 70
D	= 100
dK	= 130
Dynamisk belastning C (kN)	= 1716
M	= 55
O	= 109.5

Statisk belastning C0 (kN)	= 2860
Vægt (g)	= 4200